

Retromaster LED Series Luminaires

For Use with Select V-51, V Series, Stylmaster, and Stylmaster-C Series Incandescent and Mercmaster Jr. HPS Mounting Hoods.

Appleton V-51 Series Incandescent | NEC: Class I, Division 2, Groups A, B, C, D | Wet Locations
 Appleton V Series Incandescent | NEC/CEC: Class I, Division 2, Groups A, B, C, D | Class II, Division 1, Groups E, F, G ① | Class III | Type 3R | Wet Locations
 Appleton Stylmaster Series Incandescent | NEC/CEC: Class I, Division 2, Groups A, B, C, D | Type 4X | Wet Locations
 Appleton Stylmaster-C Series Incandescent | CEC: Class I, Division 2, Groups A, B, C, D | Class II, Division 1, Groups E, F, G | Class III | Type 4X | Wet Locations
 Appleton Mercmaster Jr. High Pressure Sodium | NEC: Class I, Division 2, Groups A, B, C, D | Class II, Division 1, Groups E, F, G
 Killark™ ✦ V Series Incandescent | NEC/CEC: Class I, Division 2, Groups A, B, C, D | Class I, Zone 2, Groups IIC, IIB, IIA | Type 3 | Wet Locations

Applications

- Enclosed and gasketed retrofit fixture — for retrofitting ② :
 - 60 to 300W
 - V-51™ Incandescent Luminaires
 - Stylmaster™ Incandescent Luminaires
 - Stylmaster-C Incandescent Luminaires - Canadian
 - 60 to 150W
 - V Incandescent Luminaires - Canadian
 - Killark™ ✦ V Series Incandescent Fixtures
 - 50 to 150W
 - Mercmaster™ Jr. High Pressure Sodium (HPS) Luminaires
- Typical applications include:
 - Stairwells
 - Elevator pits
 - Eye wash and first aid stations
 - Emergency call stations
 - Exits, doorway lighting
 - Underground tunnels
 - Outdoor walkways
 - Docks
 - Class I, Division 2 area where extra light is required

Features

- Compact, lightweight design to easily retrofit legacy lighting installations.
- Retrofit to LED in less than a minute.
- Two light outputs provide up to 5000 lumens:

Nominal Lumens ③	Incandescent Equivalent	Model
1000 or 2000	60-150W	RETROLEDV1BU RETROLEDS1BU
3500 or 5000	200-300W	RETROLEDV5BU RETROLEDS5BU

- 7W to 38W LED replaces 60 to 300 Watt incandescent.
- Color temperature (CCT): 5000K cool white (70 CRI min).
- Mounts to the following legacy mounting hoods:
 - Appleton Incandescent
 - V-51 (NEC), V Series (low lumen offering in the V/VH Series) (NEC/CEC), Stylmaster (NEC/CEC), Stylmaster-C (CEC)
 - Appleton High Pressure Sodium (HPS)
 - Mercmaster Jr. (NEC)
 - Killark™ ✦ Incandescent
 - V Series (NEC/CEC)
- Lightweight 0.82 to 2.27 (1.8 to 5.0 lbs)
- Ambient Temperature: -40 °C to +40 °C (-40 °F to +104 °F).
- Universal voltage: 120-277 Vac, 50/60 Hz.
- Standard 6 kV surge suppression.
- LED L70 reported at 60,000 hours.
- Photometric data and electronic drawings available upon request.

① Class II, Division 1 with pendant mount only.

② Mounting hood retrofit certification is based on each separate legacy lighting series. Not all legacy hoods are applicable, check family tree for suitability.

③ Nominal lumen value for 5000K, clear polycarbonate globe, Type V Wide optic. Detailed lumen information is provided in the "Lumen Output (Efficacy)" tables.

✦ Killark is a registered trademark of Hubbell Incorporated.

⊕ For warranty details go to www.appleton.emerson.com.



RETROLEDV1BU



RETROLEDS1BU



RETROLEDV5BU



RETROLEDS5BU

Warranty ④

- 5 year standard warranty.

Options

- All models;
 - Globe guard available, *purchase separately*.
 - Colored polycarbonate globes available, *purchase separately*.

Standard Materials

- Fixture housing: cast copperfree (4/10 of 1% max.) aluminum
- Gaskets: silicone rubber
- All hardware and catch assemblies: stainless steel
- Globe: polycarbonate
- Globe guard: stainless steel

Standard Finishes

- Fixture housing: gray epoxy powder coat finish, electrostatically applied for complete uniform protection

NEC/CEC Certifications and Compliances

- UL Standard: UL 50E; UL 50; UL 844; UL 1598; UL 1598C; UL 8750
- CSA Standard: C22.2 No. 94.1; C22.2 No. 94.2; C22.2 No. 137; C22.2 No. 250.0; C22.2 No. 250.1; C22.2 No. 250.13
- cETLus Listed: 5027927

DesignLights™ Consortium

- Check DLC QPL for current list of products.

Retromaster LED Series Luminaires

For Use with Select V-51, V Series, Stylmaster, and Stylmaster-C Series Incandescent and Mercmaster Jr. HPS Mounting Hoods.

Appleton V-51 Series Incandescent | NEC: Class I, Division 2, Groups A, B, C, D | Wet Locations
 Appleton V Series Incandescent | NEC/CEC: Class I, Division 2, Groups A, B, C, D | Class II, Division 1, Groups E, F, G ① | Class III | Type 3R | Wet Locations
 Appleton Stylmaster Series Incandescent | NEC/CEC: Class I, Division 2, Groups A, B, C, D | Type 4X | Wet Locations
 Appleton Stylmaster-C Series Incandescent | CEC: Class I, Division 2, Groups A, B, C, D | Class II, Division 1, Groups E, F, G | Class III | Type 4X | Wet Locations
 Appleton Mercmaster Jr. High Pressure Sodium | NEC: Class I, Division 2, Groups A, B, C, D | Class II, Division 1, Groups E, F, G
 Killark™ ⚡ V Series Incandescent | NEC/CEC: Class I, Division 2, Groups A, B, C, D | Class I, Zone 2, Groups IIC, IIB, IIA | Type 3 | Wet Locations

Illustrated Features

User Selectable Lumen Output



High Lumen Setting

Low Lumen Setting

Fixtures offer dual lumen outputs that are selectable by the user.

Diffused Polycarbonate Globe



Provides usable, comfortable lighting in all applications. Light pattern similar to incandescent seen in BUG rating levels.

Universal Retrofit Compatible with Appleton and Killark ⚡ ②



Legacy V-51 Incandescent

Retromaster LED

Provides the means of updating outdated lighting sources in minutes to energy efficient LEDs by allowing the end-user to seamlessly retrofit pre-existing V-51, Stylmaster, Stylmaster-C, V Series, and Killark™ ⚡ V Series select mounting hoods.

Ease of Installation



Quick easy installation to upgrade to LED in about a minute.

Optional Wire Guard



Stainless steel wire guard (GUARDL/GUARDH) can be used for additional protection.

Optional Colored Globes



Optional polycarbonate color globes available in red (RECAPL/RECAPH), green (GRCAPL/GRCAPH), blue (BLCAPL/BLCAPH), and amber (AMCAPL/AMCAPH). Used as indicator lights in multiple applications.

① Class II, Division 1 with pendant mount only.

② Mounting hood retrofit certification is based on each separate legacy lighting series. Not all legacy hoods are applicable, check family tree for suitability.

⚡ Killark is a registered trademark of Hubbell Incorporated.

Retromaster LED Series Luminaires

For Use with Select V-51, V Series, Stylmaster, and Stylmaster-C Series Incandescent and Mercmaster Jr. HPS Mounting Hoods.

Appleton V-51 Series Incandescent | NEC: Class I, Division 2, Groups A, B, C, D | Wet Locations

Family Tree — Retromaster LED Series Luminaires — V-51 Series Incandescent — 60 to 300W — NEC Only

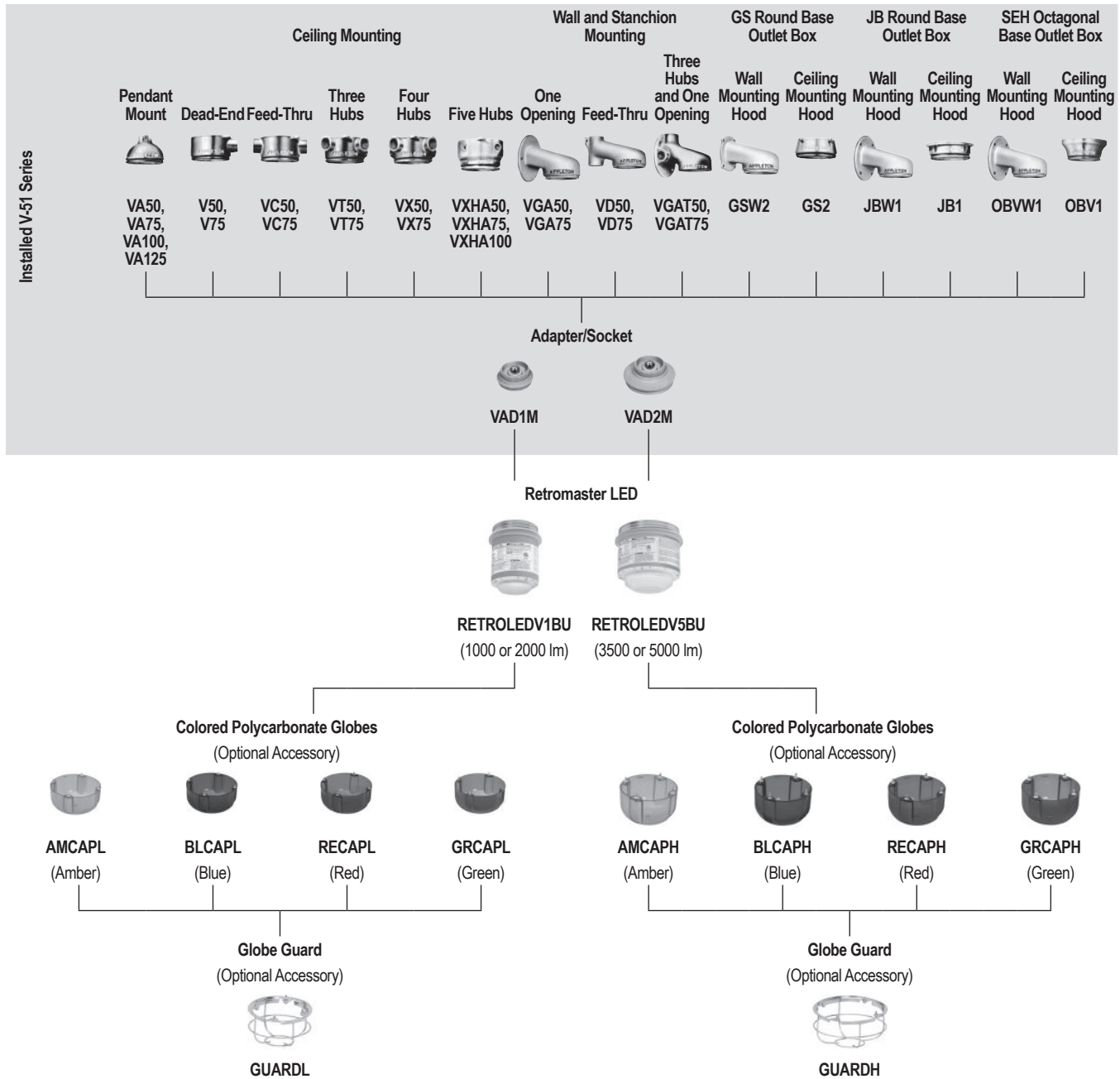

Retromaster LED Series Luminaires

For Use with Select V-51, V Series, Stylmaster, and Stylmaster-C Series Incandescent and Mercmaster Jr. HPS Mounting Hoods.

Appleton V Series Incandescent | NEC/CEC : Class I, Division 2, Groups A, B, C, D | Class II, Division 1, Groups E, F, G ① | Class III | Type 3R | Wet Locations

Family Tree — Retromaster LED Series Luminaires — V Series Incandescent (Low Lumen Offering in the V/VH Series) — 60 to 150W — NEC and CEC

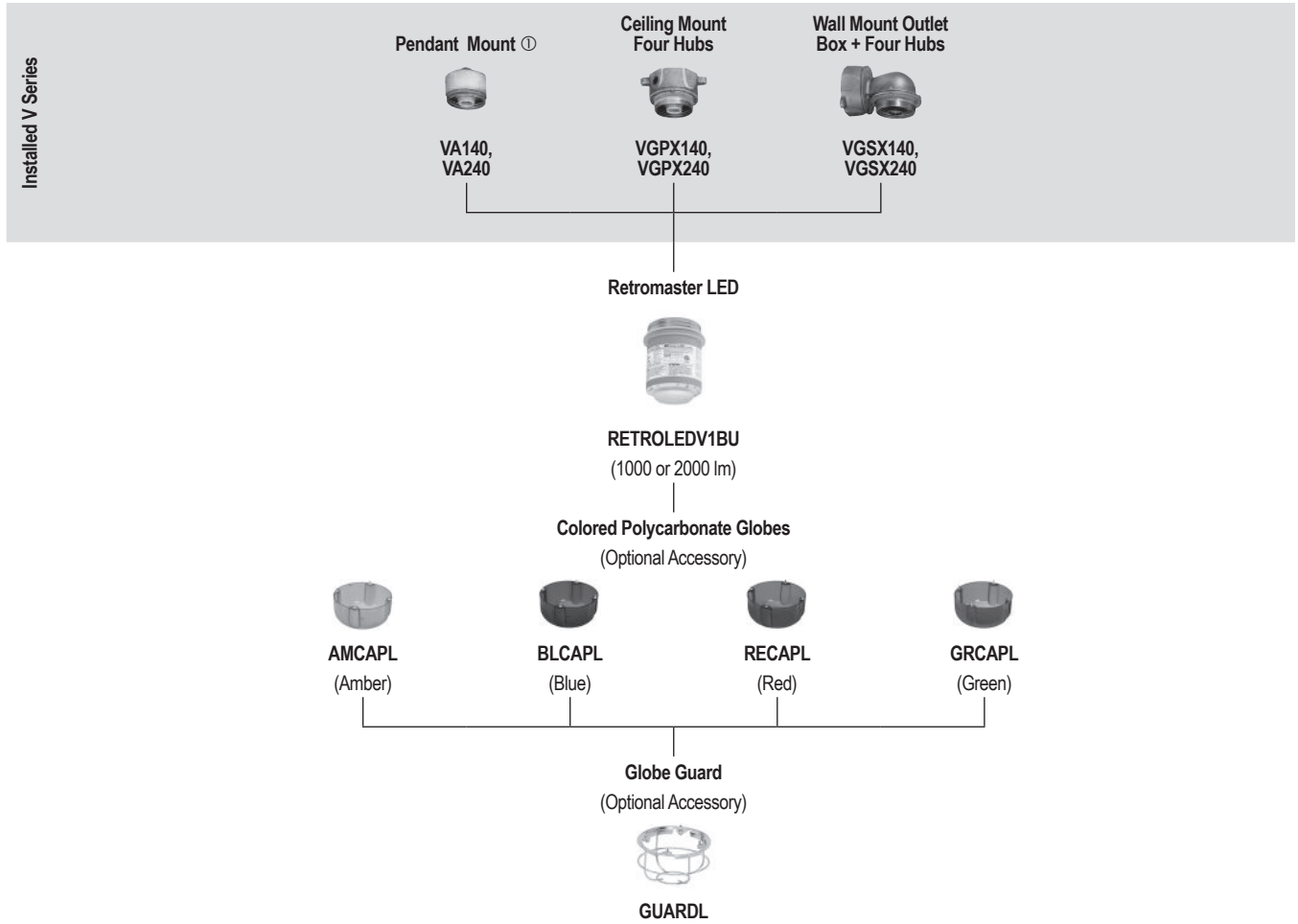

① Class II, Division 1 with pendant mount only.

Retromaster LED Series Luminaires

For Use with Select V-51, V Series, Stylmaster, and Stylmaster-C Series Incandescent and Mercmaster Jr. HPS Mounting Hoods.

Appleton Stylmaster Series Incandescent | NEC/CEC: Class I, Division 2, Groups A, B, C, D | Type 4X | Wet Locations

Family Tree — Retromaster LED Series Luminaires — Stylmaster Series Incandescent — 60 to 300W — NEC and CEC

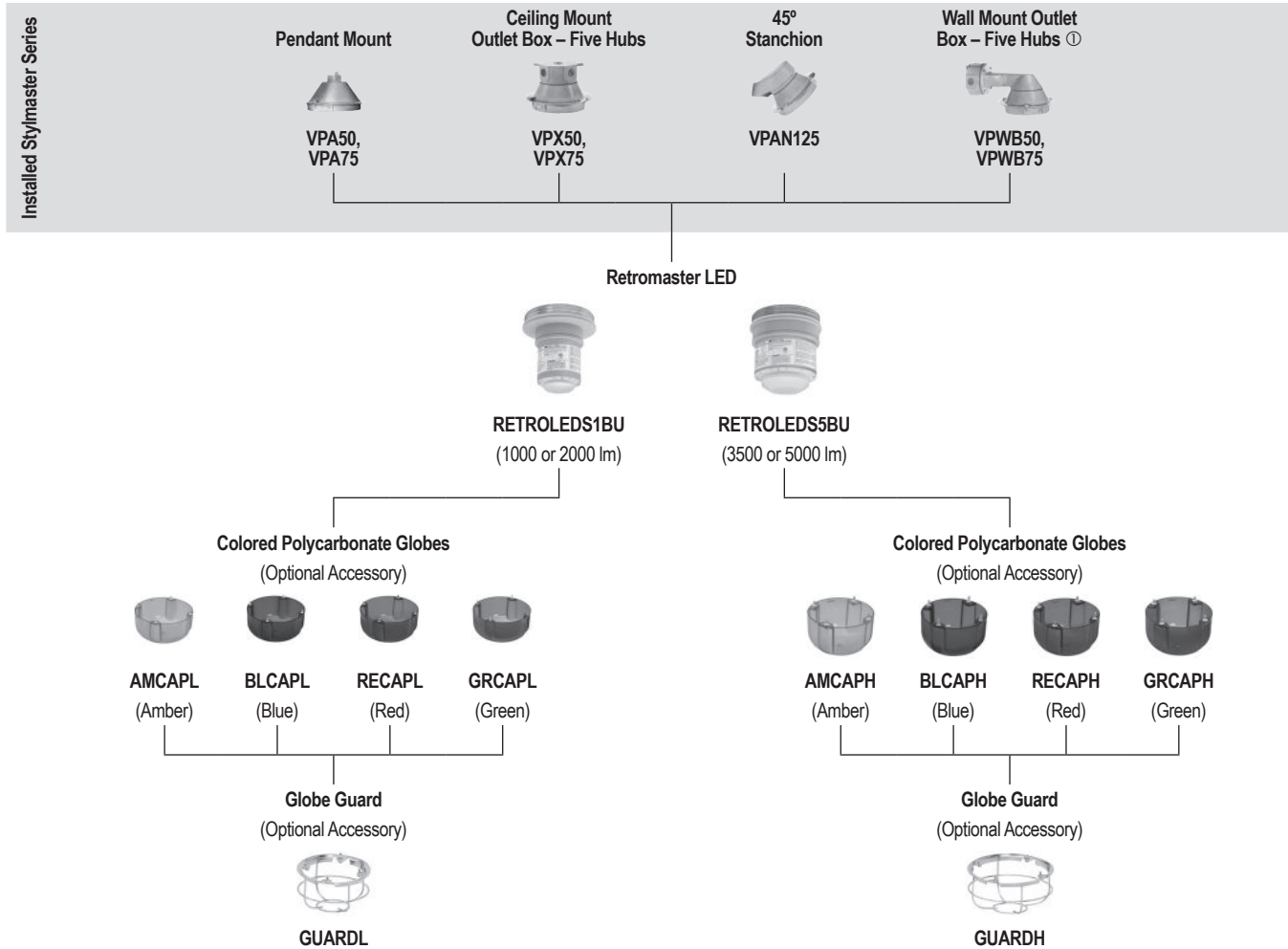

① Use 30° angle reflectors for wall installations – center line of fixture must be located at least 5-3/4" away from wall. Has four 3/16" dia. mounting holes located 90° apart on a 3-1/2" dia. center.

Retromaster LED Series Luminaires

For Use with Select V-51, V Series, Stylmaster, and Stylmaster-C Series Incandescent and Mercmaster Jr. HPS Mounting Hoods.

Appleton Stylmaster-C Series Incandescent | CEC: Class I, Division 2, Groups A, B, C, D | Class II, Division 1, Groups E, F, G | Class III | Type 4X | Wet Locations

Family Tree — Retromaster LED Series Luminaires — Stylmaster-C Series Incandescent — 60 to 300W — CEC Only

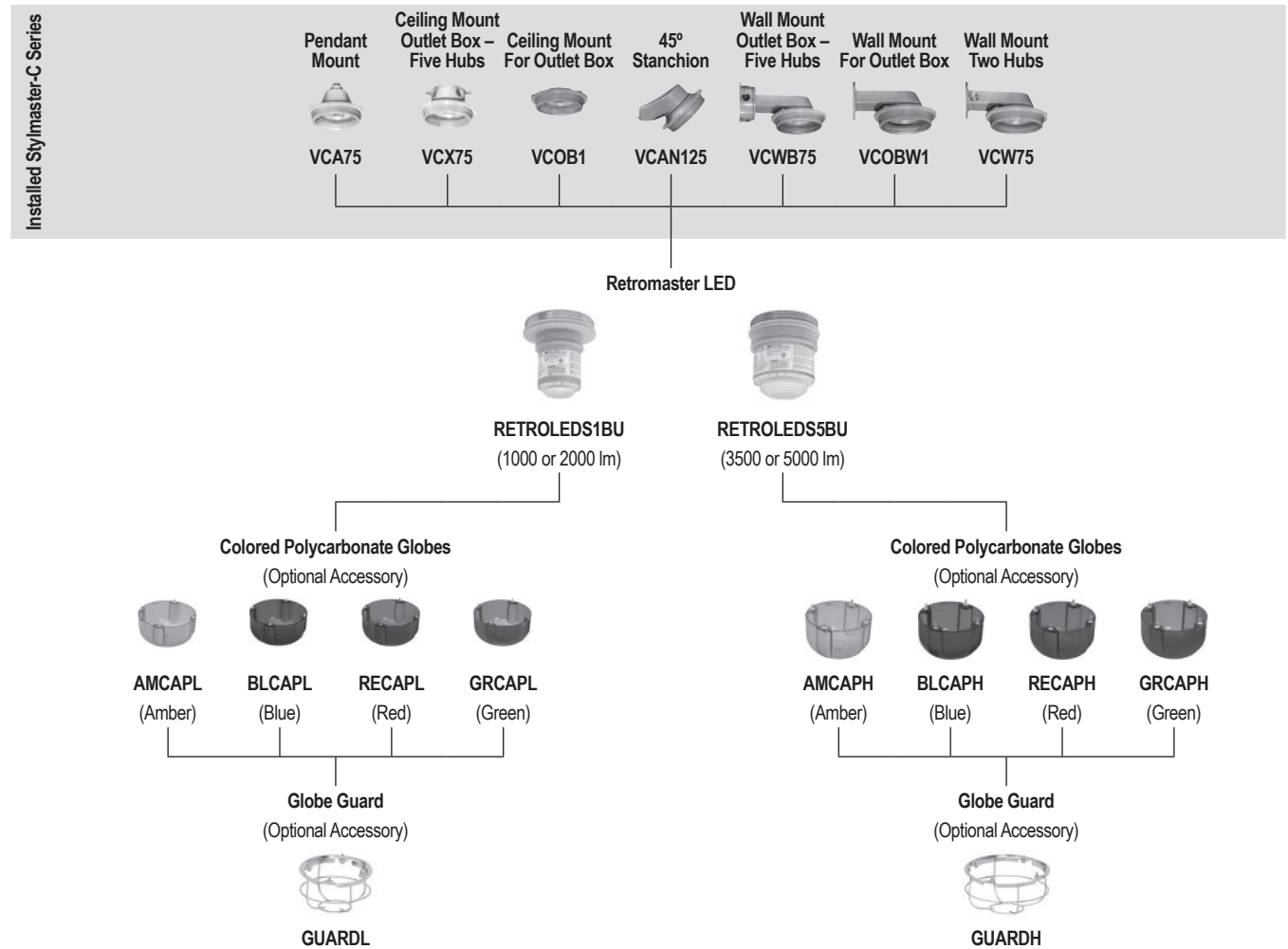

Retromaster LED Series Luminaires

For Use with Select V-51, V Series, Stylmaster, and Stylmaster-C Series Incandescent and Mercmaster Jr. HPS Mounting Hoods.

Appleton Mercmaster Jr. High Pressure Sodium | NEC: Class I, Division 2, Groups A, B, C, D | Class II, Division 1, Groups E, F, G

Family Tree — Retromaster LED Series Luminaires — Mercmaster Jr. High Pressure Sodium — 50 to 150W (HPS)— NEC Only

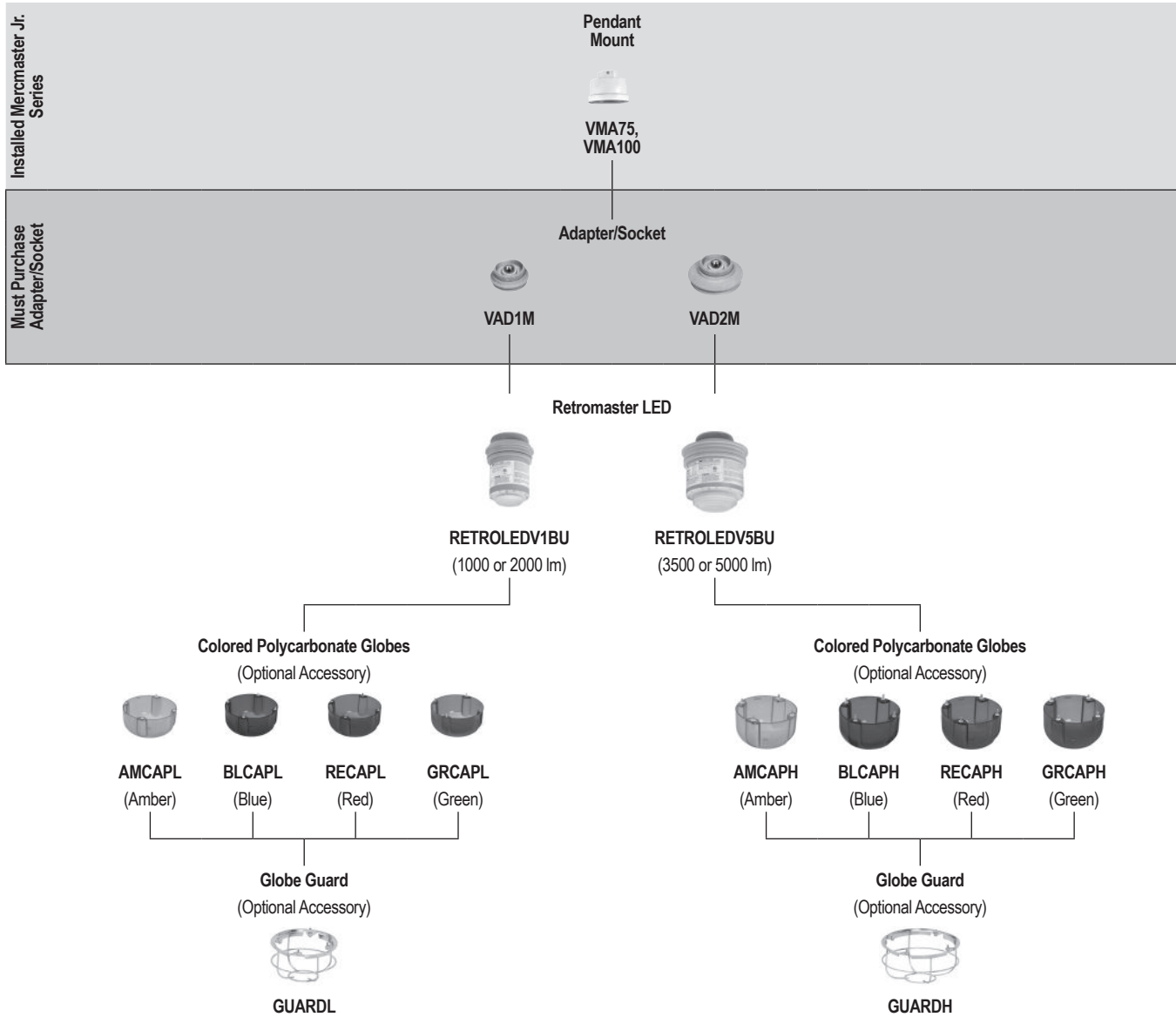

† Location classification may vary depending on the model selected. Contact your local sales representative for more details.

Retromaster LED Series Luminaires

For Use with Select V-51, V Series, Stylmaster, and Stylmaster-C Series Incandescent and Mercmaster Jr. HPS Mounting Hoods.

Killark™ ◇ V Series Incandescent | NEC/CEC: Class I, Division 2, Groups A, B, C, D | Class I, Zone 2, Groups IIC, IIB, IIA | Type 3 | Wet Locations

Family Tree — Retromaster LED Series Luminaires — Killark™ ◇ V Series Incandescent — 60 to 150W — NEC and CEC

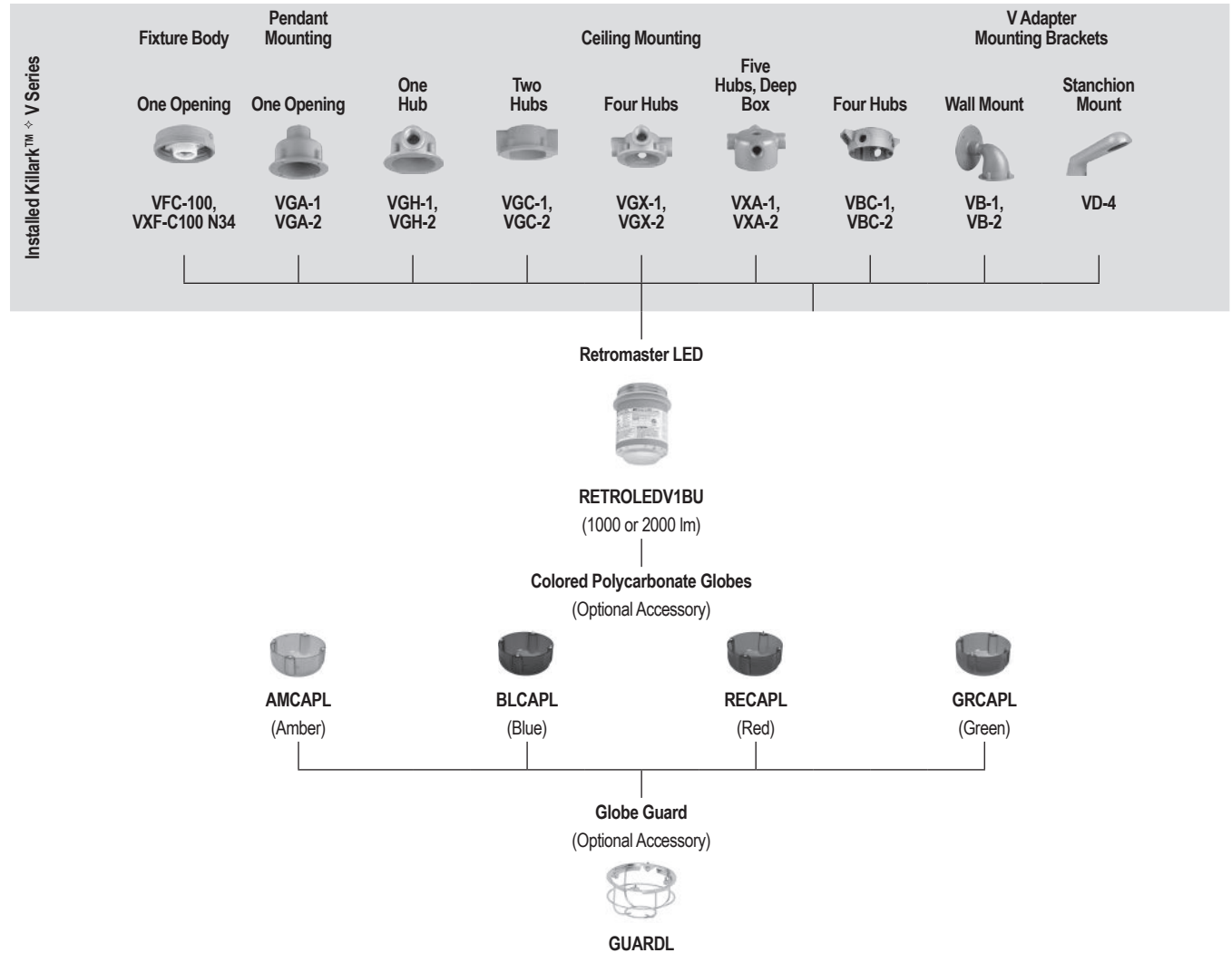

◇ Killark is a registered trademark of Hubbell Incorporated.

Retromaster LED Series Luminaires

For Use with Select V-51, V Series, Stylmaster, and Stylmaster-C Series Incandescent and Mercmaster Jr. HPS Mounting Hoods.

Appleton V-51 Series Incandescent | NEC: Class I, Division 2, Groups A, B, C, D | Wet Locations
 Appleton V Series Incandescent | NEC/CEC: Class I, Division 2, Groups A, B, C, D | Class II, Division 1, Groups E, F, G ① | Class III | Type 3R | Wet Locations
 Appleton Stylmaster Series Incandescent | NEC/CEC: Class I, Division 2, Groups A, B, C, D | Type 4X | Wet Locations
 Appleton Stylmaster-C Series Incandescent | CEC: Class I, Division 2, Groups A, B, C, D | Class II, Division 1, Groups E, F, G | Class III | Type 4X | Wet Locations
 Appleton Mercmaster Jr. High Pressure Sodium | NEC: Class I, Division 2, Groups A, B, C, D | Class II, Division 1, Groups E, F, G
 Killark™ * V Series Incandescent | NEC/CEC: Class I, Division 2, Groups A, B, C, D | Class I, Zone 2, Groups IIC, IIB, IIA | Type 3 | Wet Locations

Order Using Catalog Numbering Guide — Retromaster LED Series Luminaires

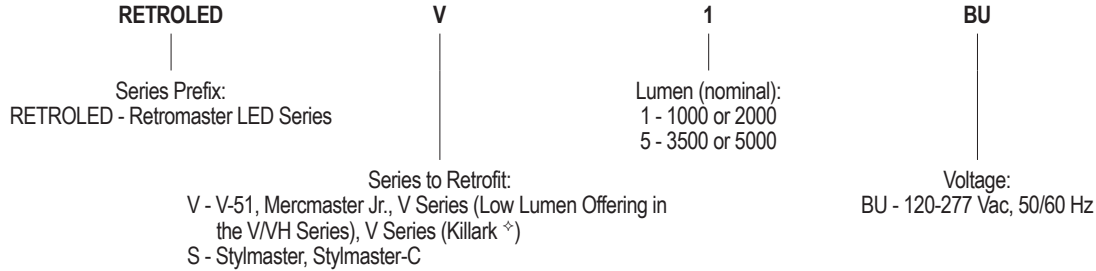

Lumen Output (Efficacy) ②

Model	Incandescent Equivalency	Light Distribution Pattern	CCT (Correlated Color Temperature)	CRI (Color Rendering Index)	Light Output — Setting 1		Light Output — Setting 2	
					Lumen Output (LM)	Efficacy (lm/W)	Lumen Output (LM)	Efficacy (lm/W)
RETROLEDV1BU	60-150W	Type V	5000K	>70	1000	141	2000	128
RETROLEDS1BU	60-150W	Type V	5000K	>70	1000	141	2000	128
RETROLEDV5BU	200-300W	Type V	5000K	>70	3500	127	5000	132
RETROLEDS5BU	200-300W	Type V	5000K	>70	3500	127	5000	132

Electrical Specifications ③ ④

Model	Voltage	Input Power (Watts)	Input Current (Amps)	Power Factor (PF)	Total Harmonic Distortion (THD)
1000 Lumen					
RETROLEDV1BU	120 Vac	7.1	0.06	0.98	12%
RETROLEDS1BU	277 Vac	8.3	0.04	0.77	27%
2000 Lumen					
RETROLEDV1BU	120 Vac	15.6	0.13	0.99	7%
RETROLEDS1BU	277 Vac	16.3	0.07	0.90	16%
3500 Lumen					
RETROLEDV5BU	120 Vac	27.6	0.23	0.99	10%
RETROLEDS5BU	277 Vac	28.3	0.12	0.90	26%
5000 Lumen					
RETROLEDV5BU	120 Vac	37.9	0.32	0.99	13%
RETROLEDS5BU	277 Vac	38.2	0.15	0.79	20%

① Class II, Division 1 with pendant mount only.

② All values are typical (+/- 10%).

③ All values are typical (tolerance +/-10%).

④ Same electrical ratings apply to each luminaire with different LED position, mounting versions and cable entries.

* Killark is a registered trademark of Hubbell Incorporated.

Retromaster LED Series Luminaires

For Use with Select V-51, V Series, Stylmaster, and Stylmaster-C Series Incandescent and Mercmaster Jr. HPS Mounting Hoods.

Appleton V-51 Series Incandescent | NEC: Class I, Division 2, Groups A, B, C, D | Wet Locations
 Appleton V Series Incandescent | NEC/CEC: Class I, Division 2, Groups A, B, C, D | Class II, Division 1, Groups E, F, G ① | Class III | Type 3R | Wet Locations
 Appleton Stylmaster Series Incandescent | NEC/CEC: Class I, Division 2, Groups A, B, C, D | Type 4X | Wet Locations
 Appleton Stylmaster-C Series Incandescent | CEC: Class I, Division 2, Groups A, B, C, D | Class II, Division 1, Groups E, F, G | Class III | Type 4X | Wet Locations
 Appleton Mercmaster Jr. High Pressure Sodium | NEC: Class I, Division 2, Groups A, B, C, D | Class II, Division 1, Groups E, F, G
 Killark™ - V Series Incandescent | NEC/CEC: Class I, Division 2, Groups A, B, C, D | Class I, Zone 2, Groups IIC, IIB, IIA | Type 3 | Wet Locations

Temperature Codes | Gas

Model Type	Gas — T Rating Ta = +40 °C (+104 °F)
RETROLEDV1BU	T5
RETROLEDV1BU	T5
RETROLEDV5BU	T4
RETROLEDV5BU	T4

Temperature Codes | Dust

Model Type	Dust — Surface T° Ta = +40 °C (+104 °F)	Dust — Series (Applicable Mounting Hood)
RETROLEDV1BU	T5	V Series (Pendant Mount)
RETROLEDV1BU	T5	Stylmaster-C Series
RETROLEDV5BU	N/A	N/A
RETROLEDV5BU	T4	Stylmaster-C Series

“T” Numbers Represent the Maximum Internal Temperature or Maximum Surface Temperature ② ③

“T” #	T1	T2	T3	T4	T5	T6
Temp. Range °C (°F)	+301 to +450 (+547 to +842)	+201 to +300 (+394 to +572)	+136 to +200 (+277 to +392)	+101 to +135 (+214 to +275)	+86 to +100 (+187 to +212)	+85 (+185)

Description	Weight in kg (lbs)
RETROLEDV1BU	0.82 (1.8)
RETROLEDV1BU	1.50 (3.3)
RETROLEDV5BU	1.09 (2.4)
RETROLEDV5BU	2.00 (4.4)

① Class II, Division 1 with pendant mount only.

② T numbers represent the maximum internal temperature for Class I, Division 2 and Class I, Zone 2 locations designated by the NEC.













③ T numbers represent the maximum surface temperature under a dust blanket for Class II, Division 1 as designated by the NEC.

Retromaster LED Series Luminaires

For Use with Select V-51, V Series, Stylmaster, and Stylmaster-C Series Incandescent and Mercmaster Jr. HPS Mounting Hoods.

Appleton V-51 Series Incandescent | NEC: Class I, Division 2, Groups A, B, C, D | Wet Locations
 Appleton V Series Incandescent | NEC/CEC: Class I, Division 2, Groups A, B, C, D | Class II, Division 1, Groups E, F, G ^① | Class III | Type 3R | Wet Locations
 Appleton Stylmaster Series Incandescent | NEC/CEC: Class I, Division 2, Groups A, B, C, D | Type 4X | Wet Locations
 Appleton Stylmaster-C Series Incandescent | CEC: Class I, Division 2, Groups A, B, C, D | Class II, Division 1, Groups E, F, G | Class III | Type 4X | Wet Locations
 Appleton Mercmaster Jr. High Pressure Sodium | NEC: Class I, Division 2, Groups A, B, C, D | Class II, Division 1, Groups E, F, G
 Killark™ V Series Incandescent | NEC/CEC: Class I, Division 2, Groups A, B, C, D | Class I, Zone 2, Groups IIC, IIB, IIA | Type 3 | Wet Locations

Accessories and Replacement Parts

	Description	Weight in kg (lbs)	Catalog Number
Adapter/Socket			
	For use on V-51 and Mercmaster Jr. Series with RETROLEDV1BU (Low Lumen Model)	0.81 (1.8)	VAD1M
	For use on V-51 and Mercmaster Jr. Series with RETROLEDV5BU (High Lumen Model)	1.18 (2.6)	VAD2M
	Description	Weight in g (oz)	Catalog Number
Colored Globes			
	Low Lumen Model Polycarbonate Globe — Amber	34 (1.2)	AMCAPL
	High Lumen Model Polycarbonate Globe — Amber	64 (2.3)	AMCAPH
	Low Lumen Model Polycarbonate Globe — Blue	34 (1.2)	BLCAPL
	High Lumen Model Polycarbonate Globe — Blue	64 (2.3)	BLCAPH
	Low Lumen Model Polycarbonate Globe — Red	34 (1.2)	RECAPL
	High Lumen Model Polycarbonate Globe — Red	64 (2.3)	RECAPH
	Low Lumen Model Polycarbonate Globe — Green	34 (1.2)	GRCAPL
	High Lumen Model Polycarbonate Globe — Green	64 (2.3)	GRCAPH
Guards			
	Low Lumen Model Globe Guard — Stainless Steel	90 (3.2)	GUARDL
	High Lumen Model Globe Guard — Stainless Steel	65 (2.3)	GUARDH

^① Class II, Division 1 with pendant mount only.

Retromaster LED Series Luminaires

For Use with Select V-51, V Series, Stylmaster, and Stylmaster-C Series Incandescent and Mercmaster Jr. HPS Mounting Hoods.

Appleton V-51 Series Incandescent | NEC: Class I, Division 2, Groups A, B, C, D | Wet Locations

Dimensions in Millimeters (Inches) — Retromaster LED Series — V-51 Series Incandescent — NEC Only

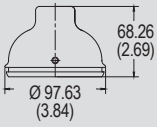
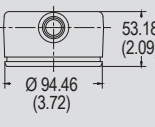
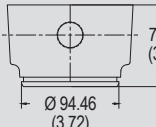
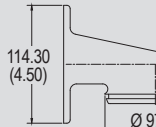
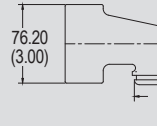
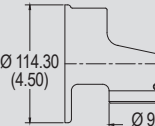
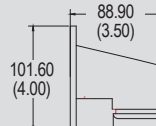
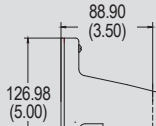
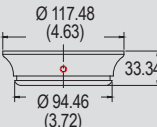
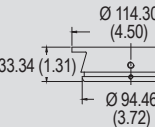
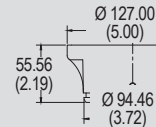
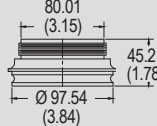
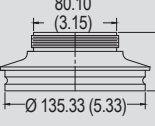
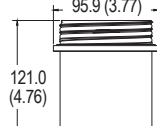
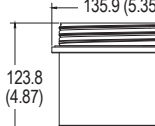
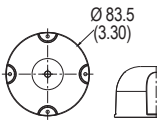
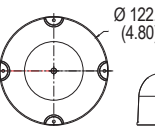
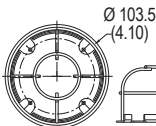
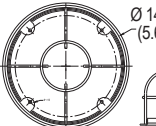
	<p>Pendant Mount: VA50, VA75, VA100, VA125</p> 	<p>Ceiling Mounting: V50, V75, VC50, VC75, VT50, VT75, VX50, VX75</p> 	<p>Ceiling Mounting: VXHA50, VXHA75, VXHA100</p> 	<p>Wall and Stanchion Mounting: VGA50, VGA75 GS Round Base Outlet Box — GSW2</p> 	
Installed Mounting Hood	<p>Wall and Stanchion Mounting: VD50, VD75</p> 	<p>Wall and Stanchion Mounting: VGAT50, VGAT75</p> 	<p>Wall Mounting: JB Round Base Outlet — JBW1,</p> 	<p>Wall Mounting: SEH Octagonal Base Outlet — OBVW1,</p> 	
	<p>Ceiling Mounting: GS Round Base Outlet Box — GS2</p> 	<p>Ceiling Mounting: JB Round Base Outlet — JB1</p> 	<p>Ceiling Mounting: SEH Octagonal Base Outlet — OBV1</p> 		
		<p>Adapter/Socket: VAD1M</p> 	<p>Adapter/Socket: VAD2M</p> 		
	<p>Retromaster LED: RETROLEDV1BU</p> 	<p>Retromaster LED: RETROLEDV5BU</p> 			
	<p>Low Lumen Model Polycarbonate Globe: AMCAPL, BLCAPL, RECAPL, GRCAPL</p> 	<p>High Lumen Model Polycarbonate Globe: AMCAPH, BLCAPH, RECAPH, GRCAPH</p> 	<p>Low Lumen Model Wire Guard: GUARDL</p> 	<p>High Lumen Model Wire Guard: GUARDH</p> 	

Retromaster LED Series Luminaires

For Use with Select V-51, V Series, Stylmaster, and Stylmaster-C Series Incandescent and Mercmaster Jr. HPS Mounting Hoods.

Appleton V Series Incandescent | NEC/CEC : Class I, Division 2, Groups A, B, C, D | Class II, Division 1, Groups E, F, G Ⓢ | Class III | Type 3R | Wet Locations

Dimensions in Millimeters (Inches) — Retromaster LED Series — V Series Incandescent (Low Lumen Offering in the VVH Series) — NEC Only

Installed Mounting Hood

Pendant Mount: VA140, VA240

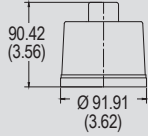

Ceiling Mounting: VGPX140, VGPX240

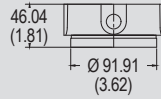

Wall Mount Outlet Box: VGSX140, VGSX240

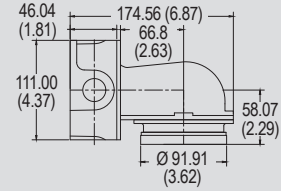

Retromaster LED: RETROLEDV1BU

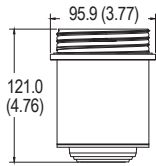

Low Lumen Model Polycarbonate Globe:
AMCAPL, BLCAPL, RECAPL, GRCAPL

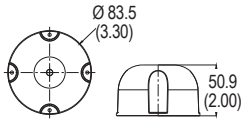

Low Lumen Model Wire Guard:
GUARDL

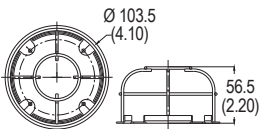

Ⓢ Class II, Division 1 with pendant mount only.

Retromaster LED Series Luminaires

For Use with Select V-51, V Series, Stylmaster, and Stylmaster-C Series Incandescent and Mercmaster Jr. HPS Mounting Hoods.

Appleton Stylmaster Series Incandescent | NEC/CEC: Class I, Division 2, Groups A, B, C, D | Type 4X | Wet Locations

Dimensions in Millimeters (Inches) — Retromaster LED Series — Stylmaster Series Incandescent — NEC and CEC

Installed Mounting Hood

Pendant Mount: VPA75

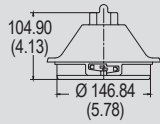

Ceiling Mount Outlet Box: VPX50, VPX75

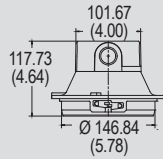

45° Stanchion Mounting: VPAN125

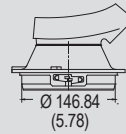

Wall Mount Outlet Box: VPWB50, VPWB75

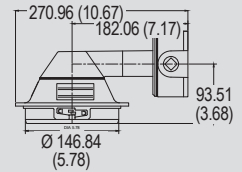

Retromaster LED:
RETROLEDS1BU

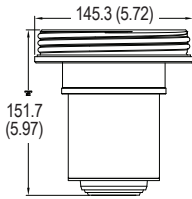

Retromaster LED:
RETROLEDS5BU

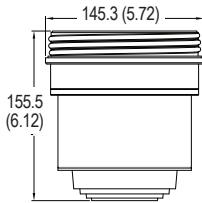

Low Lumen Model Polycarbonate
Globe: AMCAPL, BLCAPL,
RECAPL, GRCAPL

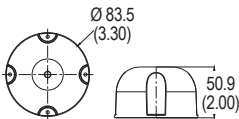

High Lumen Model Polycarbonate
Globe: AMCAPH, BLCAPH,
RECAPH, GRCAPH

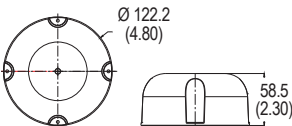

Low Lumen Model Wire Guard:
GUARDL

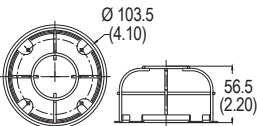

High Lumen Model Wire Guard:
GUARDH

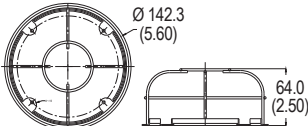

Retromaster LED Series Luminaires

For Use with Select V-51, V Series, Stylmaster, and Stylmaster-C Series Incandescent and Mercmaster Jr. HPS Mounting Hoods.

Appleton Stylmaster-C Series Incandescent | CEC: Class I, Division 2, Groups A, B, C, D | Class II, Division 1, Groups E, F, G | Class III | Type 4X | Wet Locations

Dimensions in Millimeters (Inches) — Retromaster LED Series — Stylmaster-C Series Incandescent — CEC Only

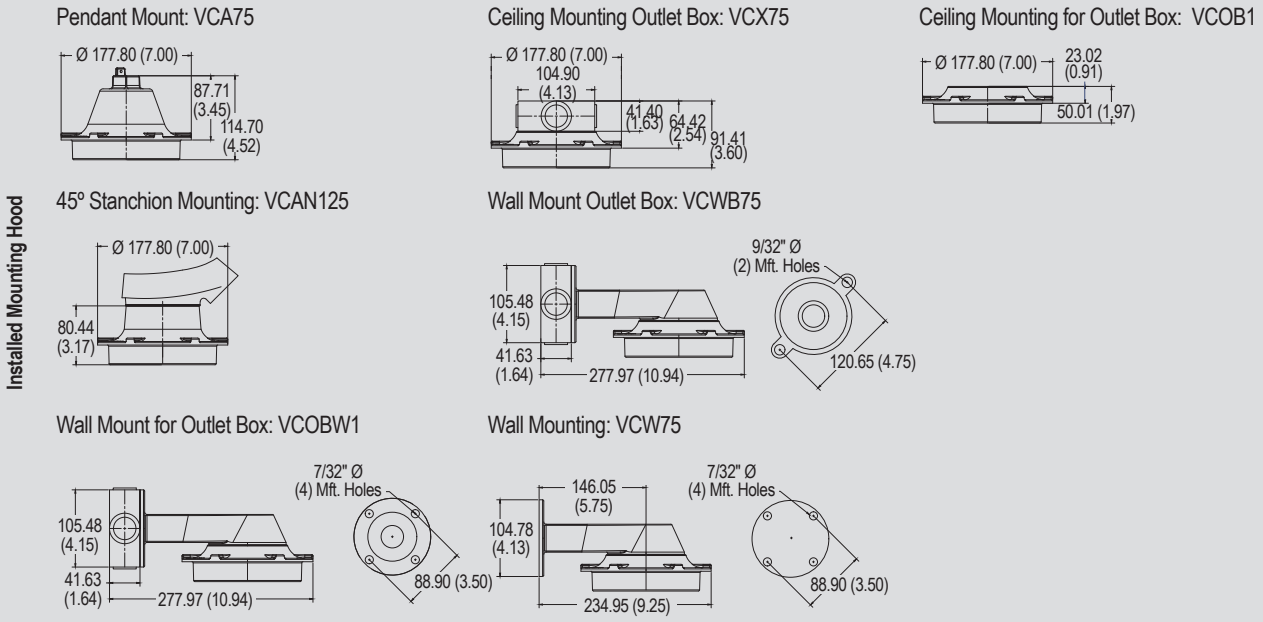

Retromaster LED: RETROLEDS1BU

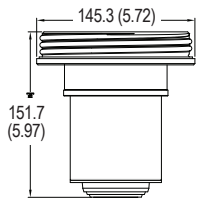

Retromaster LED: RETROLEDS5BU

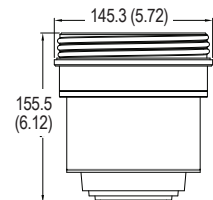

Low Lumen Model Polycarbonate Globe: AMCAPL, BLCAPL, RECAPL, GRCAPL

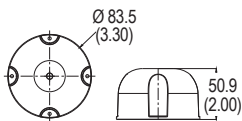

High Lumen Model Polycarbonate Globe: AMCAPH, BLCAPH, RECAPH, GRCAPH

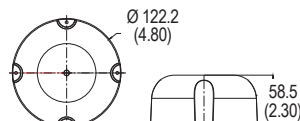

Low Lumen Model Wire Guard: GUARDL

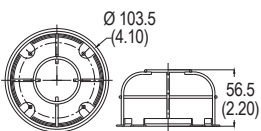

High Lumen Model Wire Guard: GUARDH

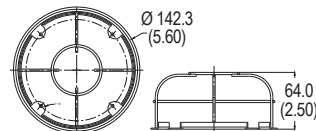

Retromaster LED Series Luminaires

For Use with Select V-51, V Series, Stylmaster, and Stylmaster-C Series Incandescent and Mercmaster Jr. HPS Mounting Hoods.

Appleton Mercmaster Jr. High Pressure Sodium | NEC: Class I, Division 2, Groups A, B, C, D | Class II, Division 1, Groups E, F, G

Dimensions in Millimeters (Inches) — Retromaster LED Series — Mercmaster Jr. High Pressure Sodium — NEC Only

Installed Mounting Hood

Pendant Mount: VMA75, VMA100

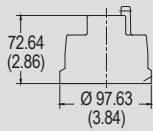

Adapter/Socket:
VAD1M

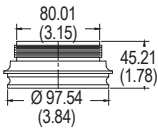

Retromaster LED:
RETROLEDV1BU

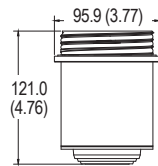

Low Lumen Model Polycarbonate
Globe: AMCAPL, BLCAPL,
RECAPL, GRCAPL

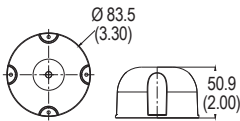

Low Lumen Model Wire Guard:
GUARDL

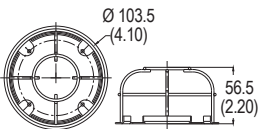

Adapter/Socket:
VAD2M

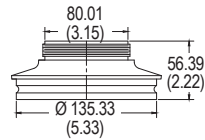

Retromaster LED:
RETROLEDV5BU

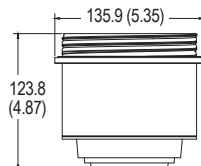

High Lumen Model Polycarbonate
Globe: AMCAPH, BLCAPH,
RECAPH, GRCAPH

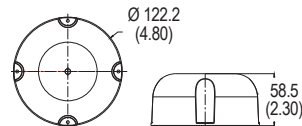

High Lumen Model Wire Guard:
GUARDH

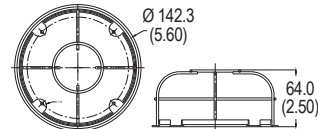

Retromaster LED Series Luminaires

For Use with Select V-51, V Series, Stylmaster, and Stylmaster-C Series Incandescent and Mercmaster Jr. HPS Mounting Hoods.

Appleton V-51 Series Incandescent | NEC: Class I, Division 2, Groups A, B, C, D | Wet Locations
 Appleton V Series Incandescent | NEC/CEC: Class I, Division 2, Groups A, B, C, D | Class II, Division 1, Groups E, F, G [Ⓞ] | Class III | Type 3R | Wet Locations
 Appleton Stylmaster Series Incandescent | NEC/CEC: Class I, Division 2, Groups A, B, C, D | Type 4X | Wet Locations
 Appleton Stylmaster-C Series Incandescent | CEC: Class I, Division 2, Groups A, B, C, D | Class II, Division 1, Groups E, F, G | Class III | Type 4X | Wet Locations
 Appleton Mercmaster Jr. High Pressure Sodium | NEC: Class I, Division 2, Groups A, B, C, D | Class II, Division 1, Groups E, F, G
 Killark™ V Series Incandescent | NEC/CEC: Class I, Division 2, Groups A, B, C, D | Class I, Zone 2, Groups IIC, IIB, IIA | Type 3 | Wet Locations

Photometric Data — Polar Candela Distribution — DATA SHOWN IS ABSOLUTE

Type V | 1000 Lumen

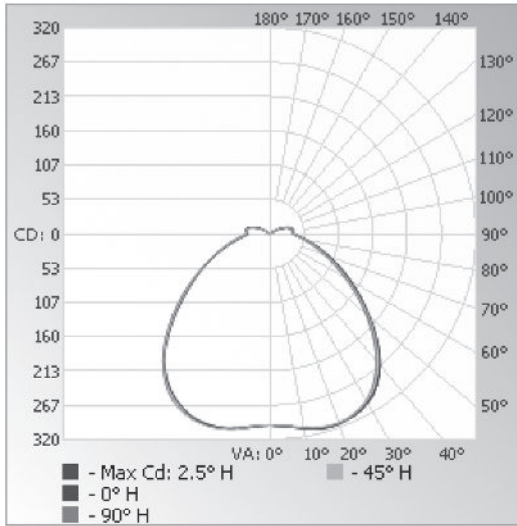

Type V | 2000 Lumen

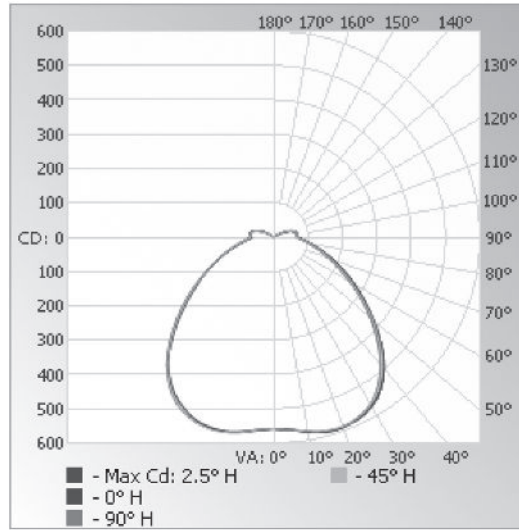

Type V | 3500 Lumen

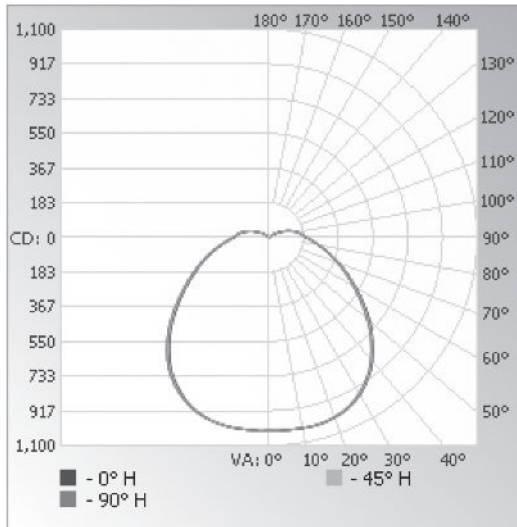

Type V | 5000 Lumen

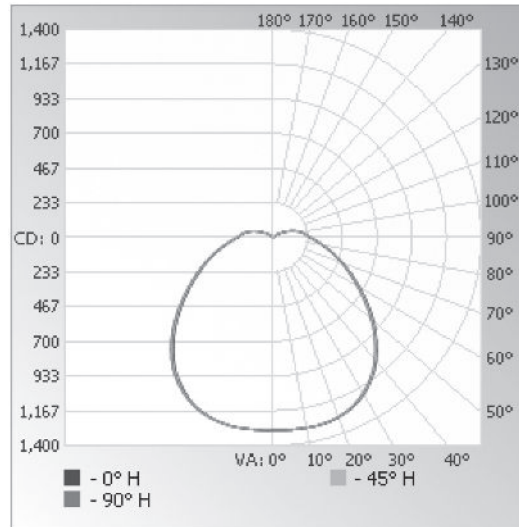

[Ⓞ] Class II, Division 1 with pendant mount only.